

Regimen A - Induction

Flowsheet 1



BM

ITMTX



Mercaptopurine

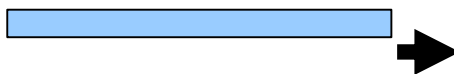

CoTrimox



Day
Week
Date

1	8	15
6	7	8

Regimen A - consolidation

Flowsheet 2

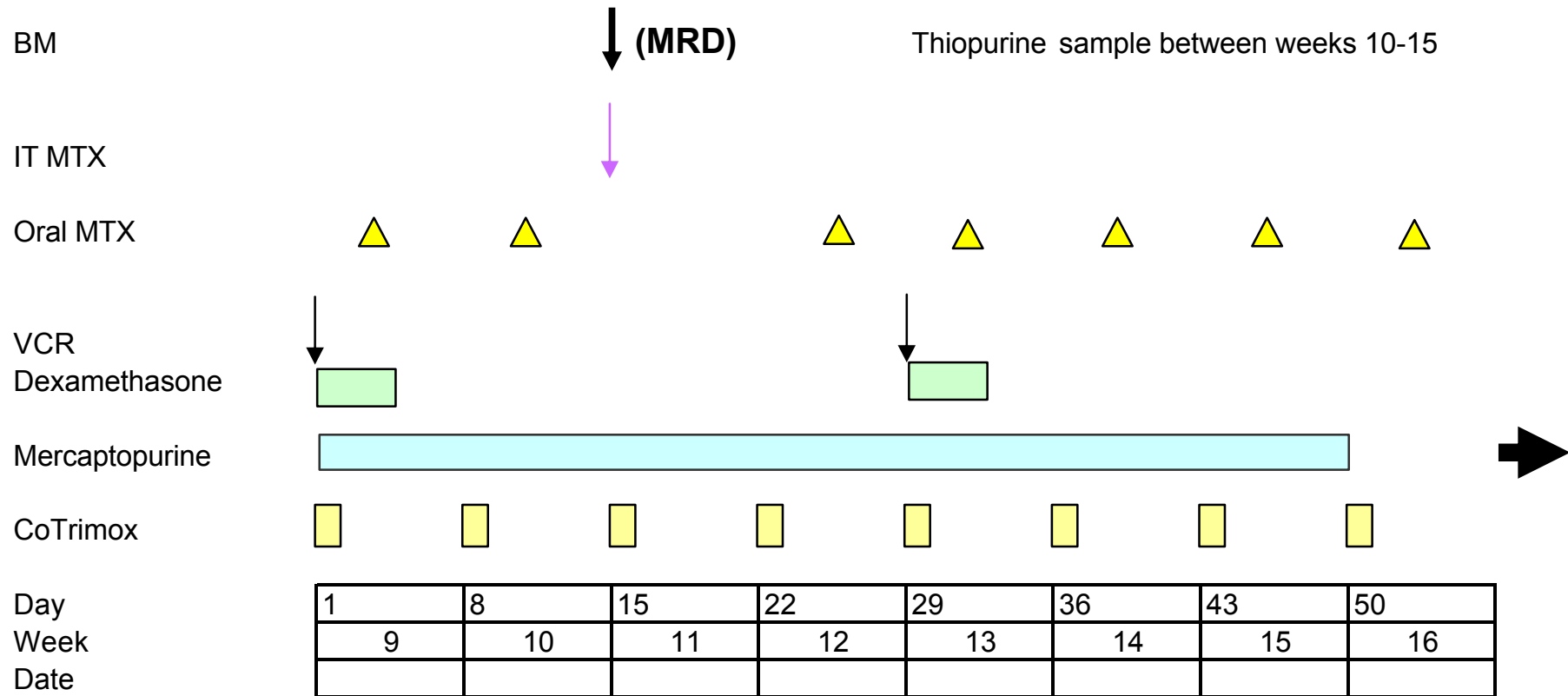

Regimen A Interim maintenance no 1

Flowsheet 3

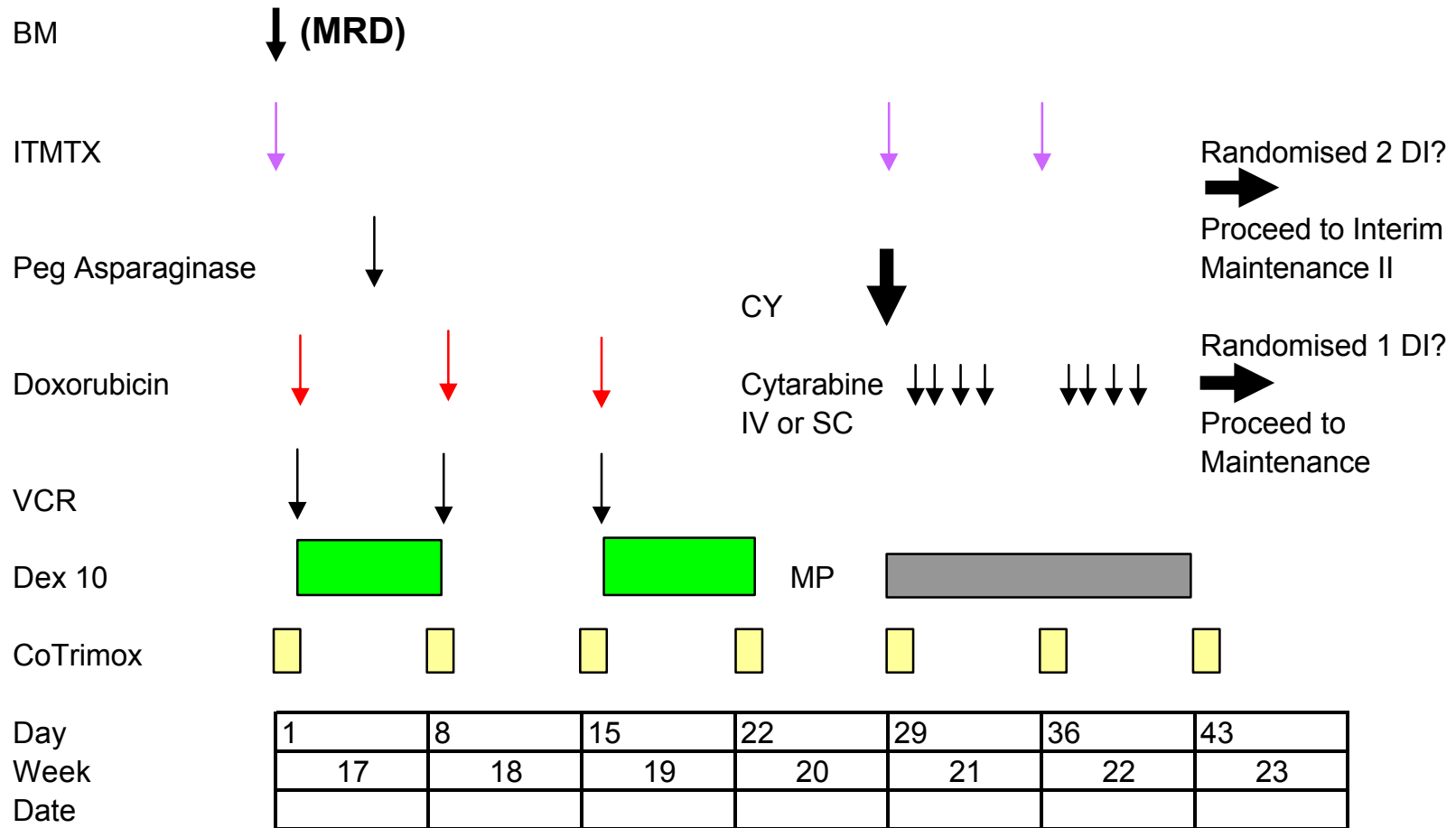

Regimen A - Delayed intensification no 1

Flowsheet 4

For patients randomised to 2 Delayed Intensifications

Oral MTX



VCR



Dexamethasone



6-MP



CoTrimox



Day

1	8	15	22	29	36	43	50
---	---	----	----	----	----	----	----

Week

24	25	26	27	28	29	30	31
----	----	----	----	----	----	----	----

Date

--	--	--	--	--	--	--	--

Regimen A - Interim maintenance no 2

Flowsheet 5

For patients randomised to 2 Delayed Intensifications

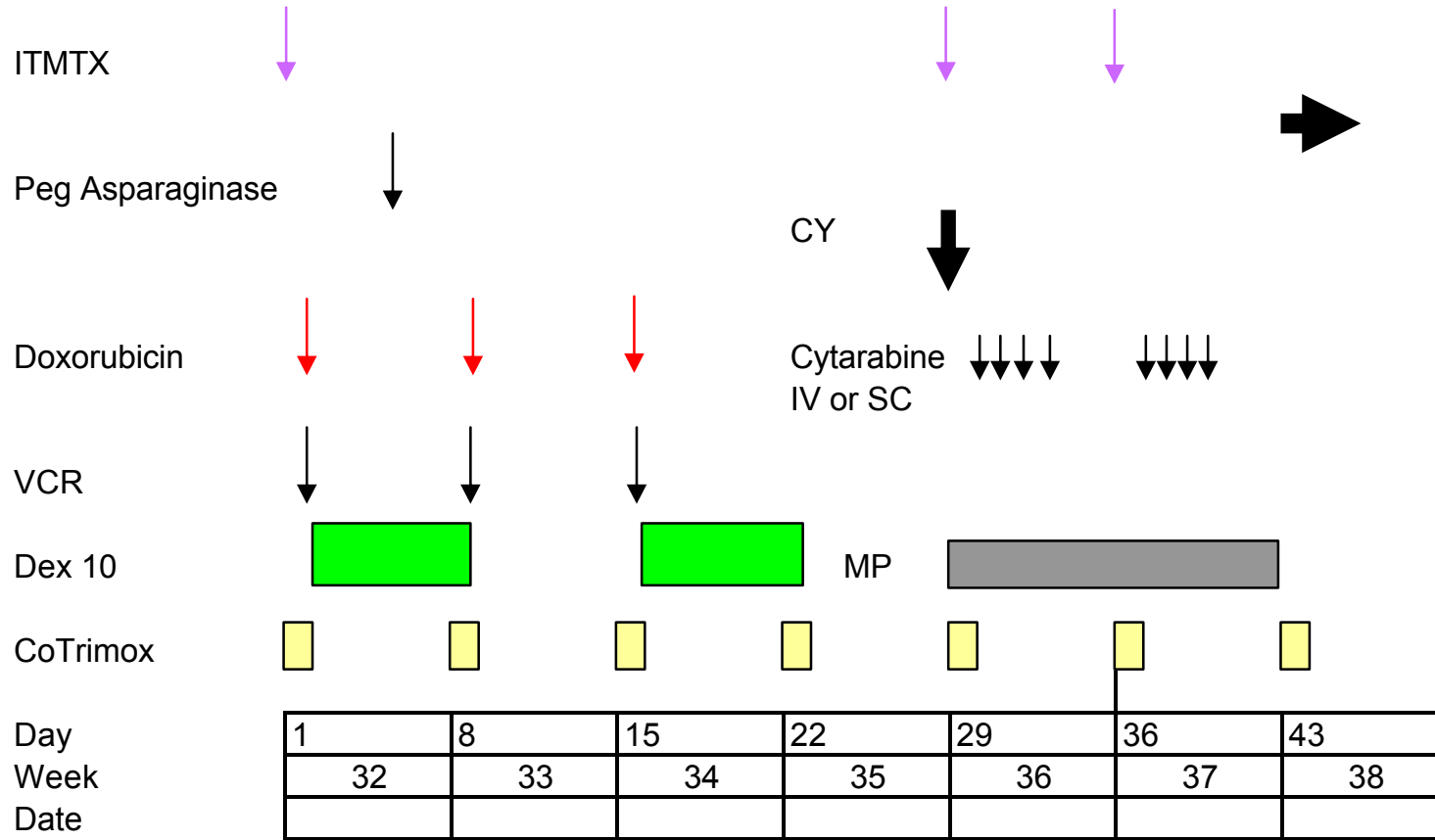

Regimen A - Delayed intensification no 2

Flowsheet 6

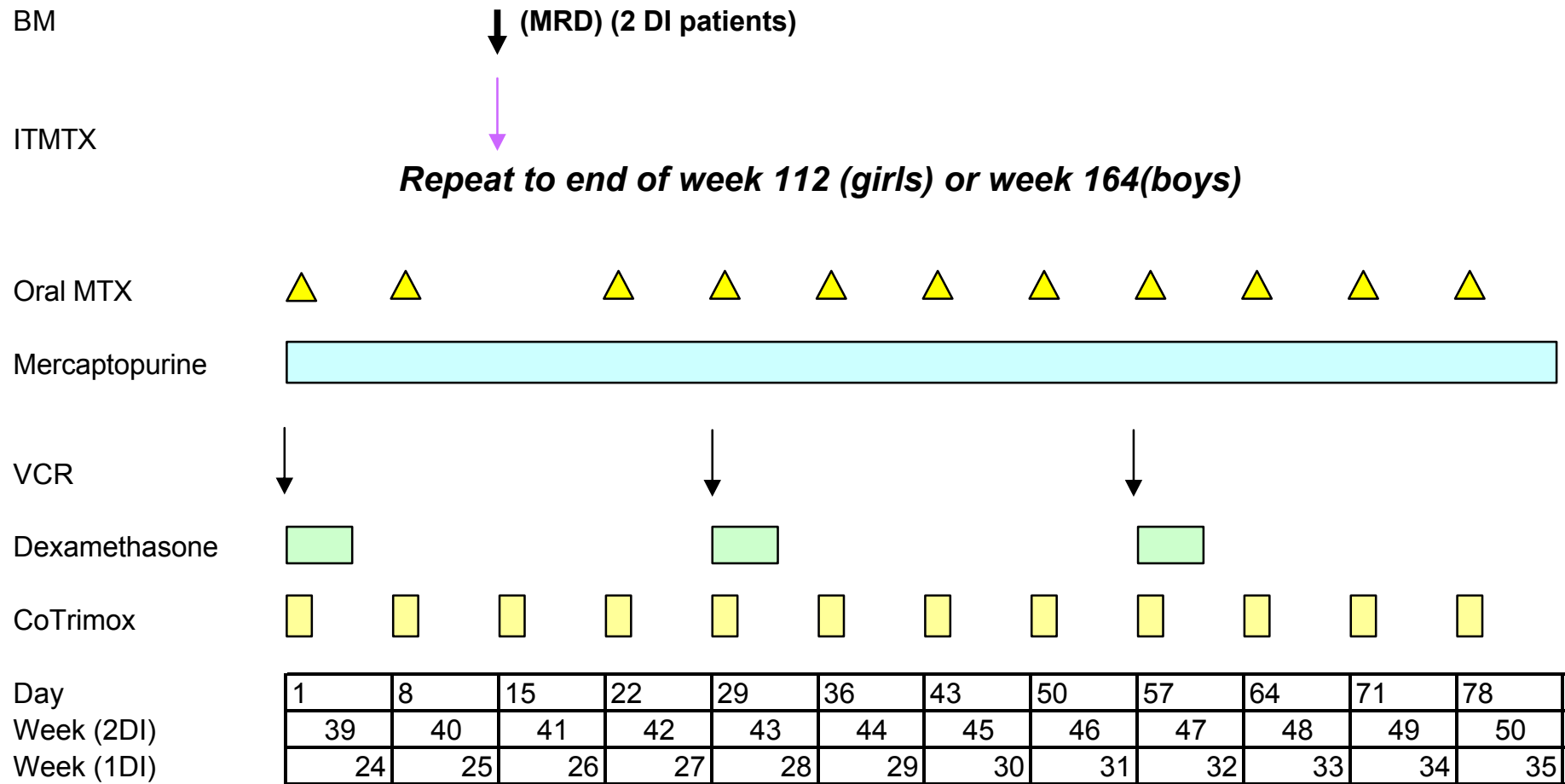

Regimen A - Maintenance cycle 1
(Starts at week 24 for patients randomised to one Delayed Intensification)
Flowsheet 7a

BM

↓ (MRD) (1DI patients)

ITMTX



Oral MTX



Mercaptopurine

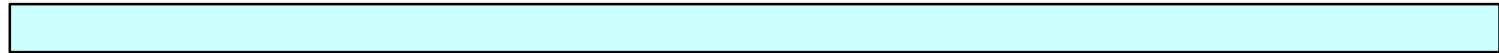

VCR



Dexamethasone



CoTrimox



Day

1	8	15	22	29	36	43	50	57	64	71	78
---	---	----	----	----	----	----	----	----	----	----	----

Week (2 x DI)

51	52	53	54	55	56	57	58	59	60	61	62
----	----	----	----	----	----	----	----	----	----	----	----

Week (1 x DI)

36	37	38	39	40	41	42	43	44	45	46	47
----	----	----	----	----	----	----	----	----	----	----	----

Regimen A - Maintenance cycle 2

Flowsheet 7b

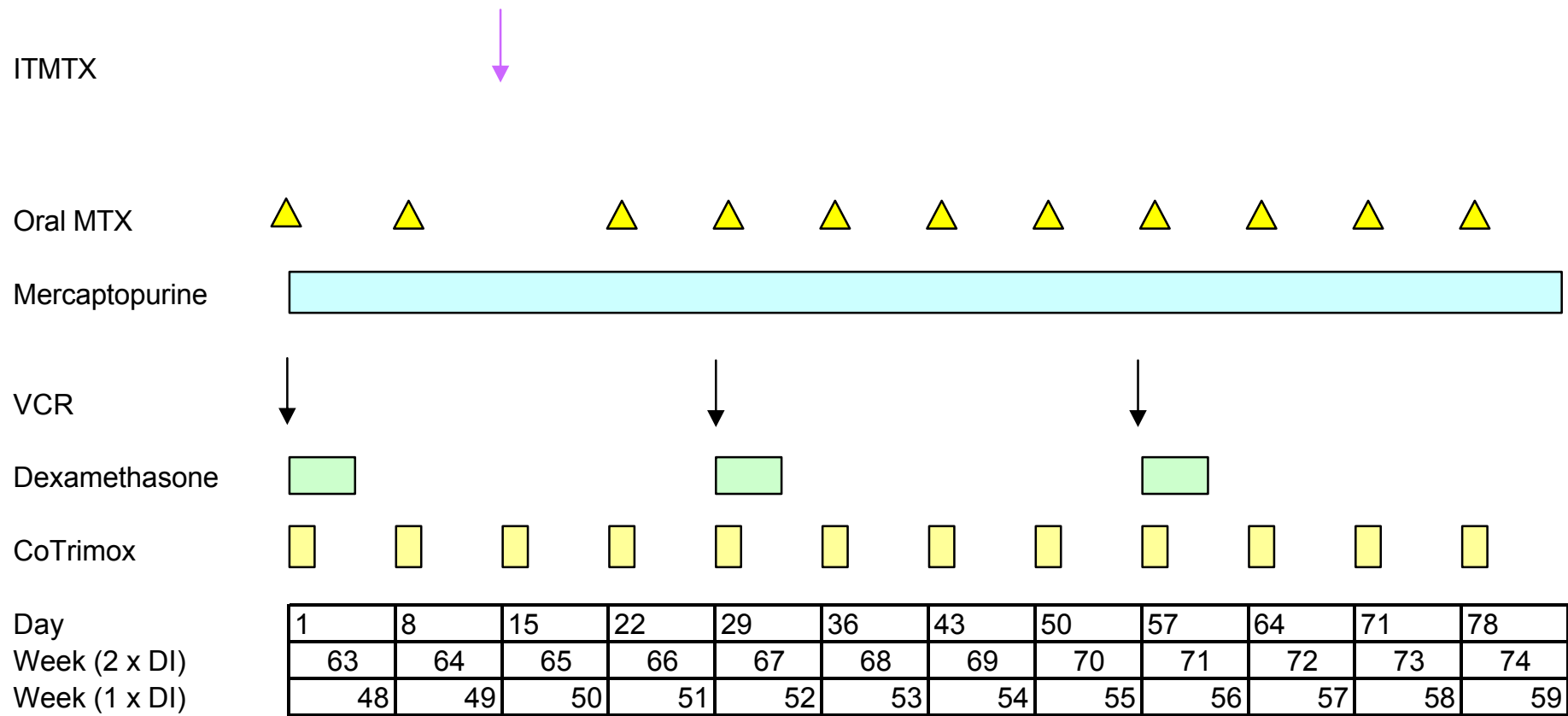

Regimen A - Maintenance cycle 3

Flowsheet 7c

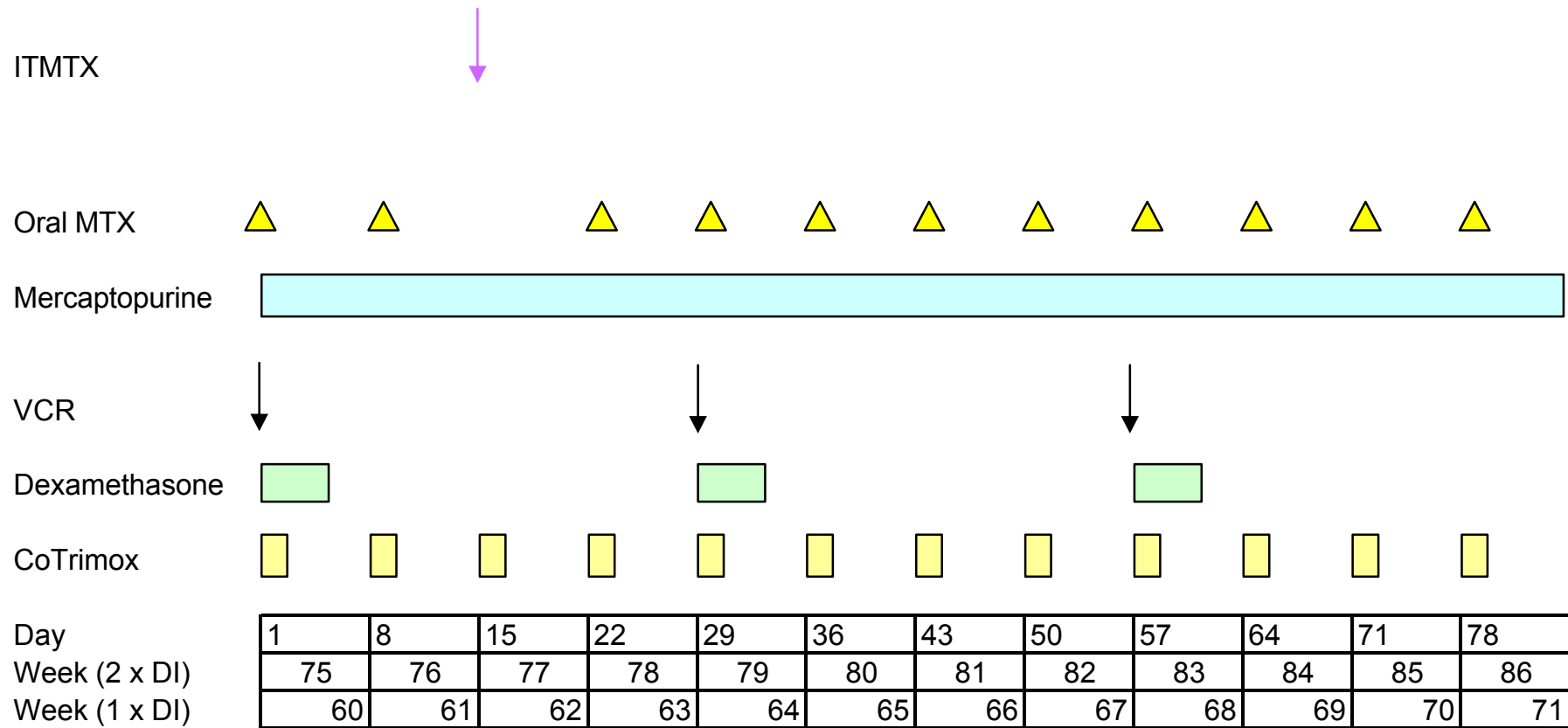

Regimen A - Maintenance cycle 4

Flowsheet 7d

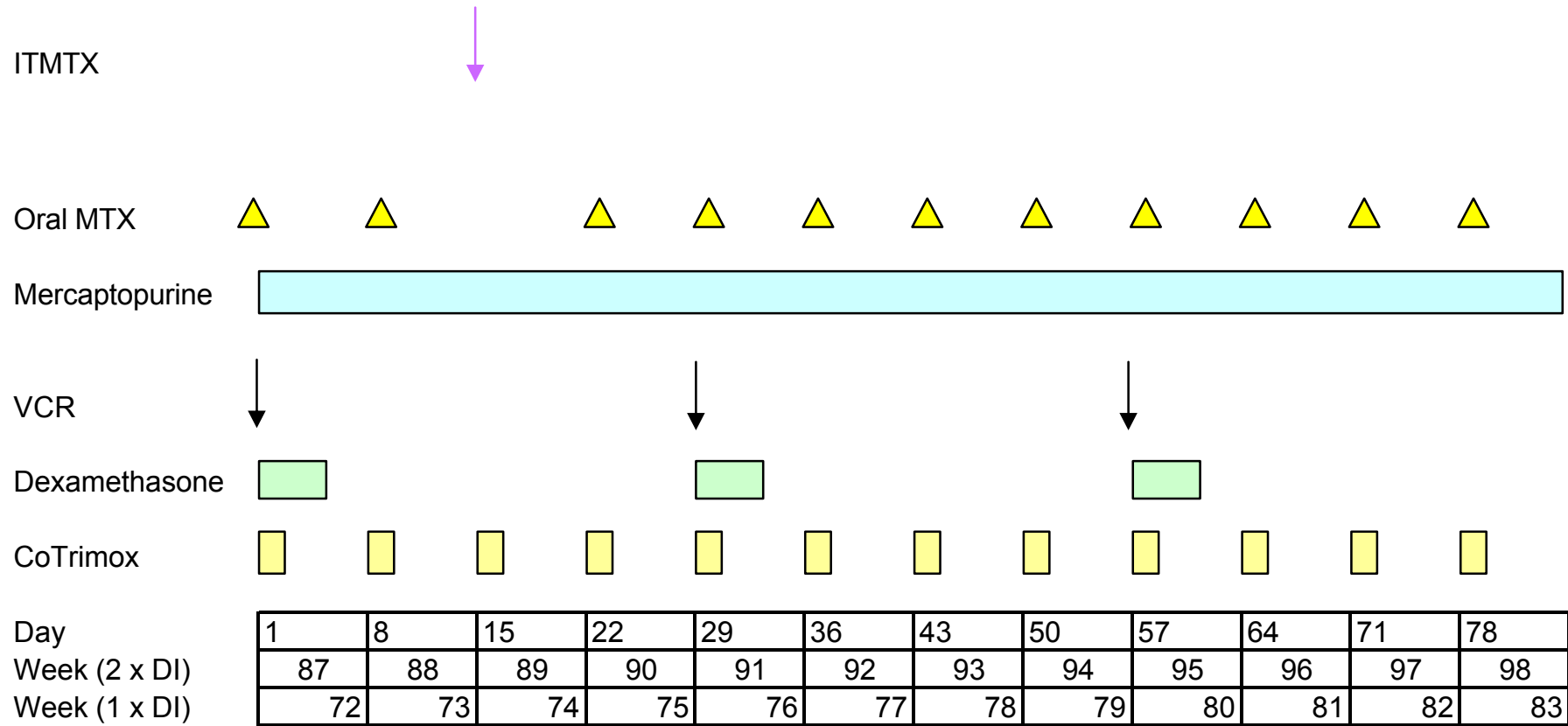

Regimen A - Maintenance cycle 5

Flowsheet 7e

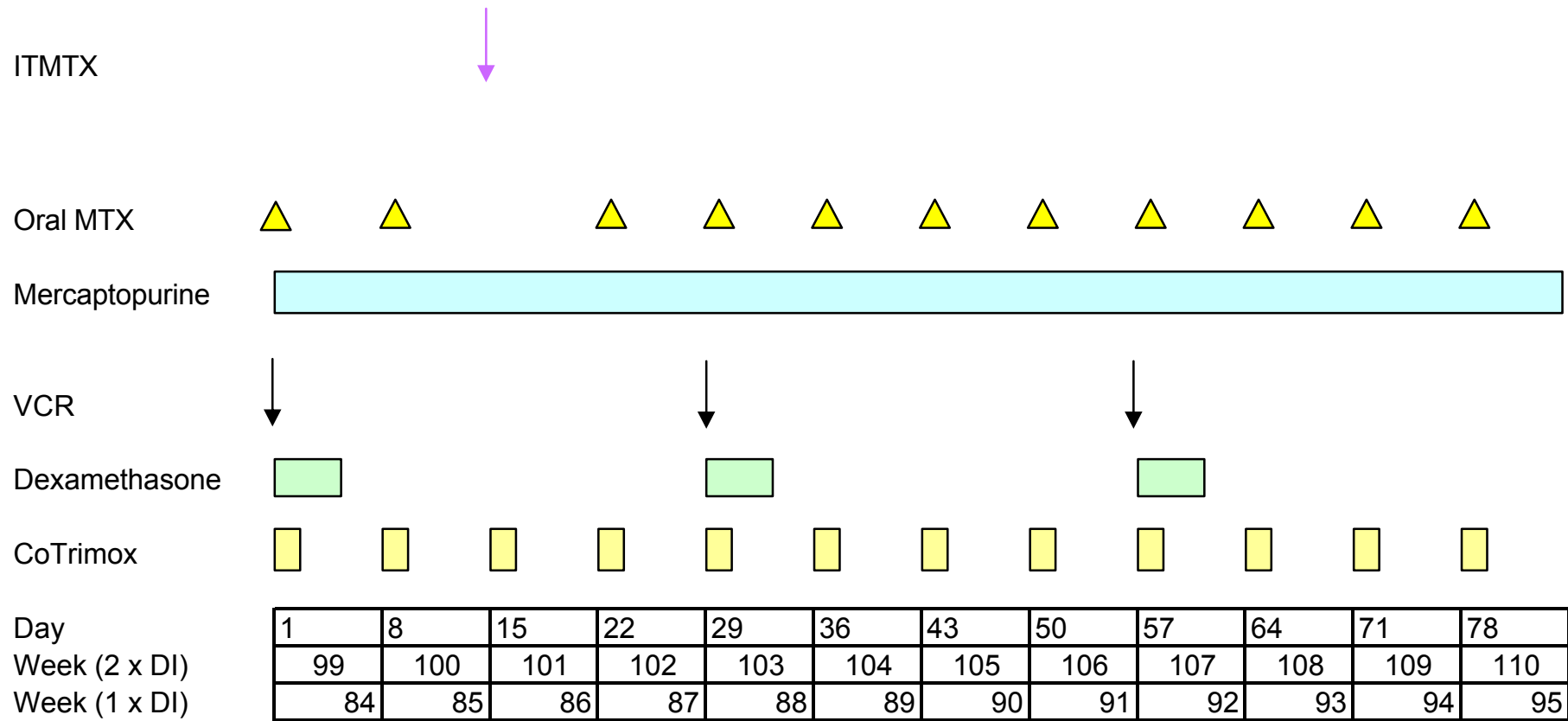

Regimen A - Maintenance cycle 6

Flowsheet 7f

2 x DI Girls stop therapy at week 112 with a final bone marrow (MRD) and LP
NB. Girls having a single delayed intensification continue treatment to cycle 8 day 35

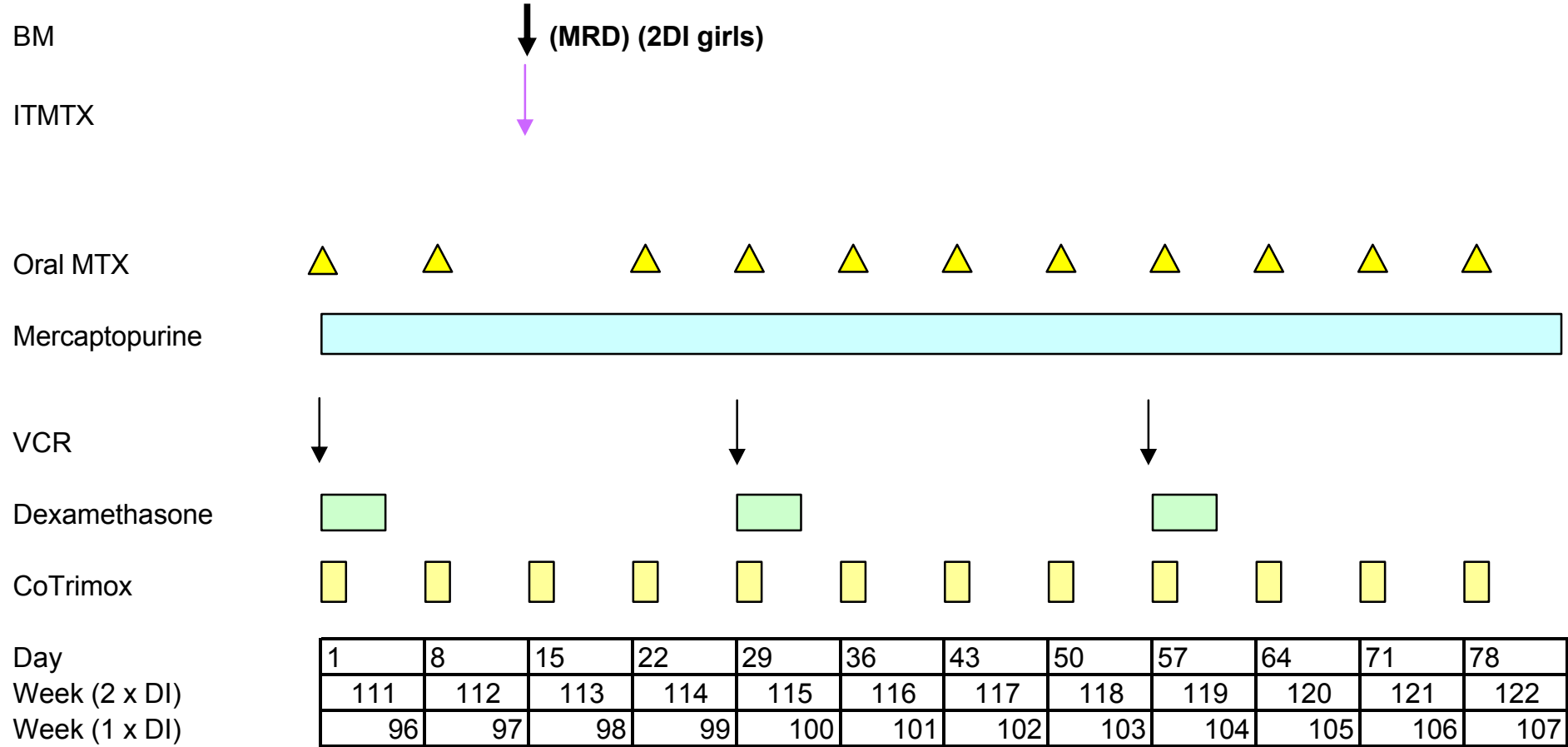

**Regimen A - Maintenance cycle 7
 Flowsheet 7g**

EOT for girls having a single delayed intensification is D35 (BM marked)

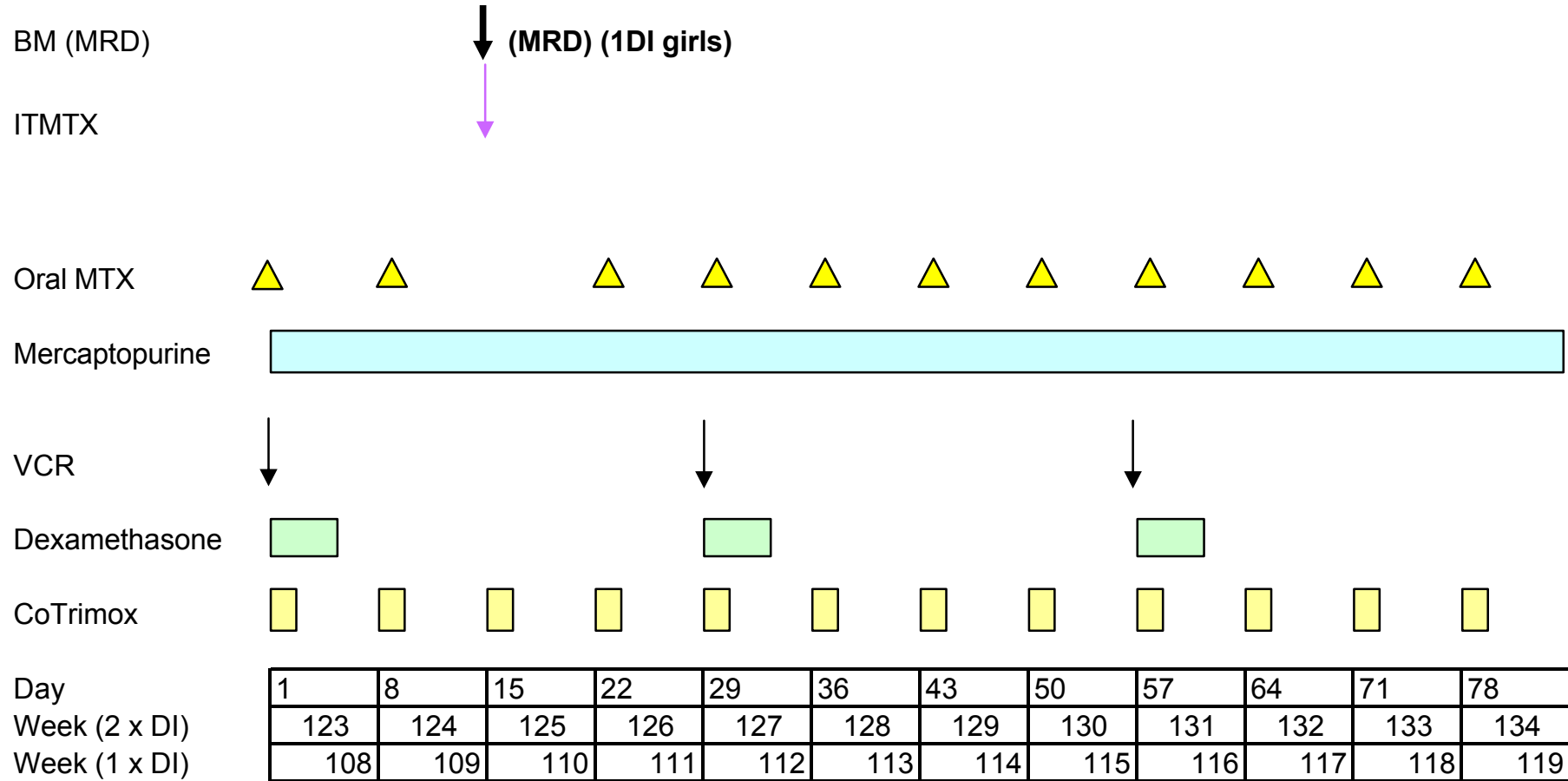

Regimen A - Maintenance cycle 8

Flowsheet 7h

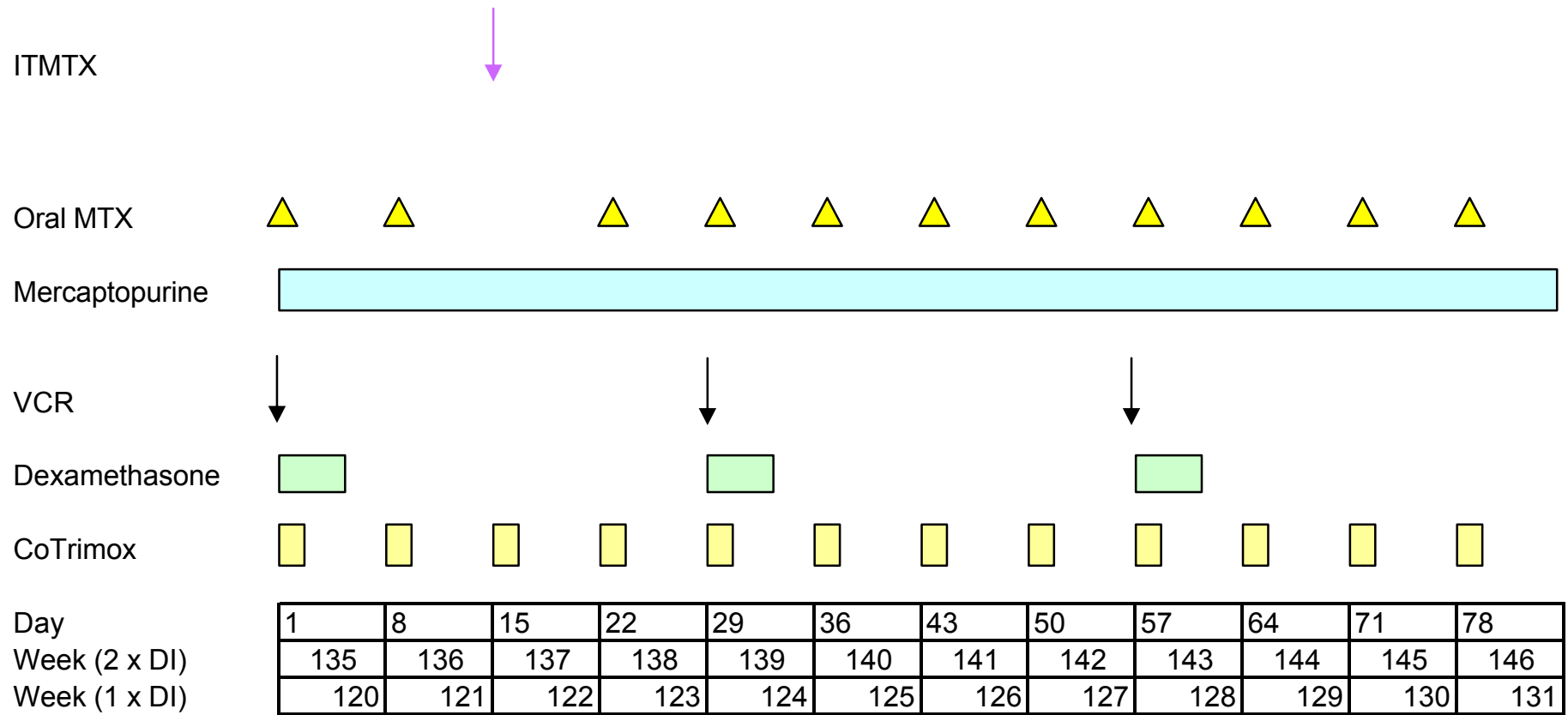

Regimen A - Maintenance cycle 9

Flowsheet 7i

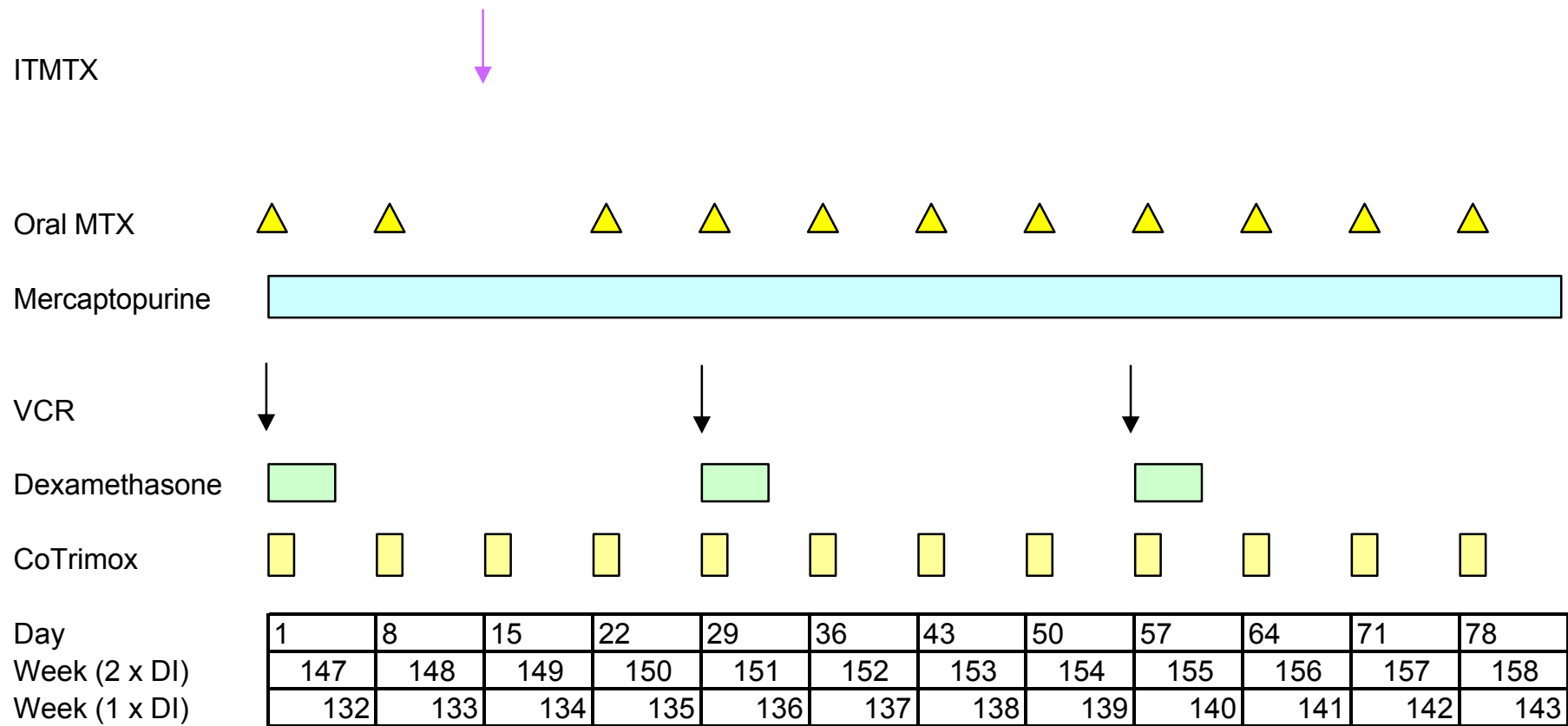

Regimen A - Maintenance cycle 10

Flowsheet 7j

2 x DI Boys finish treatment at week 164 with a final bone marrow (MRD) and LP
NB Boys having a single DI continue to cycle 12 D64

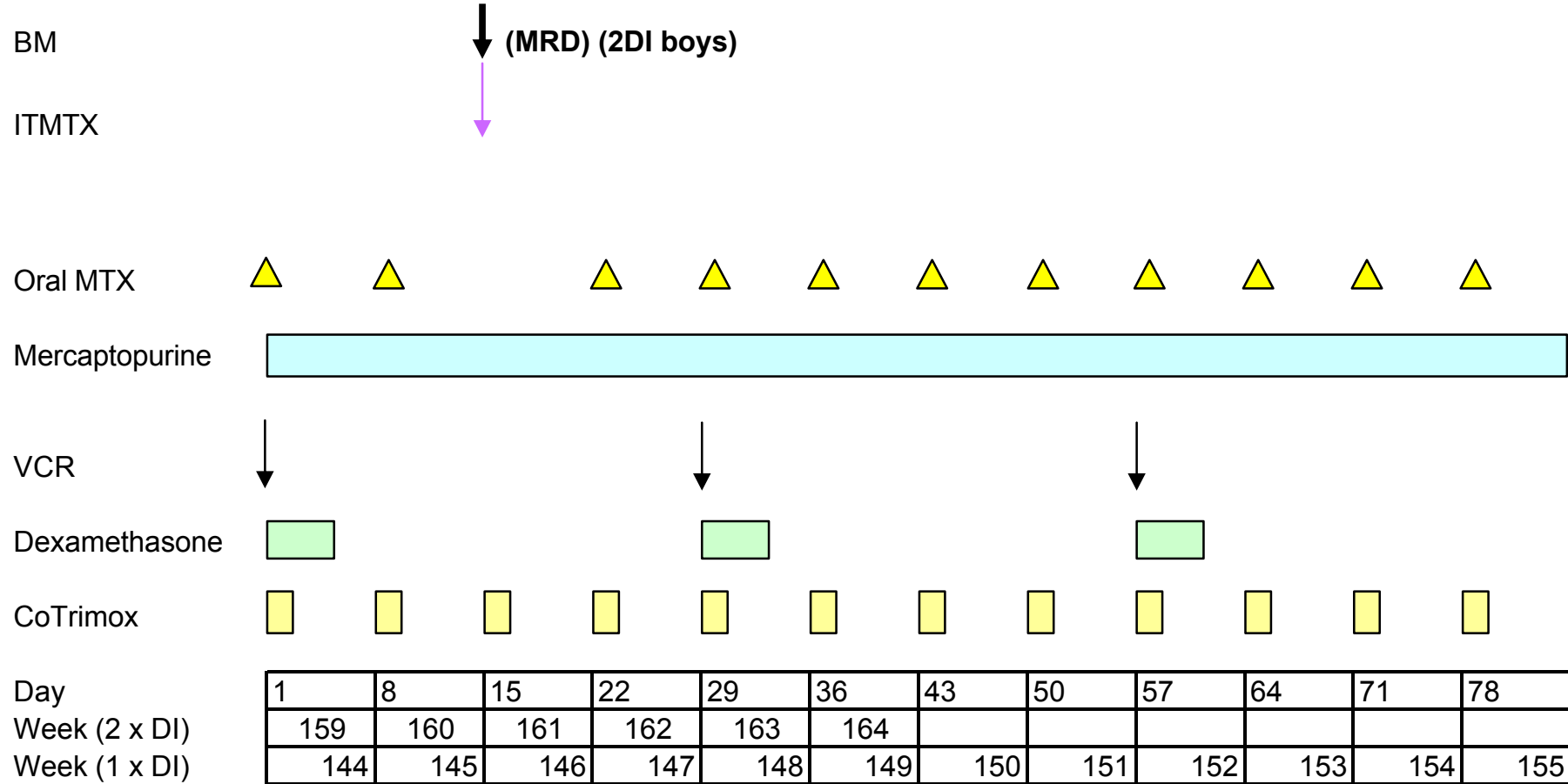

Regimen A - Maintenance cycle 11
Flowsheet 7k

NB Boys having a single DI finish treatment on D64 cycle 12

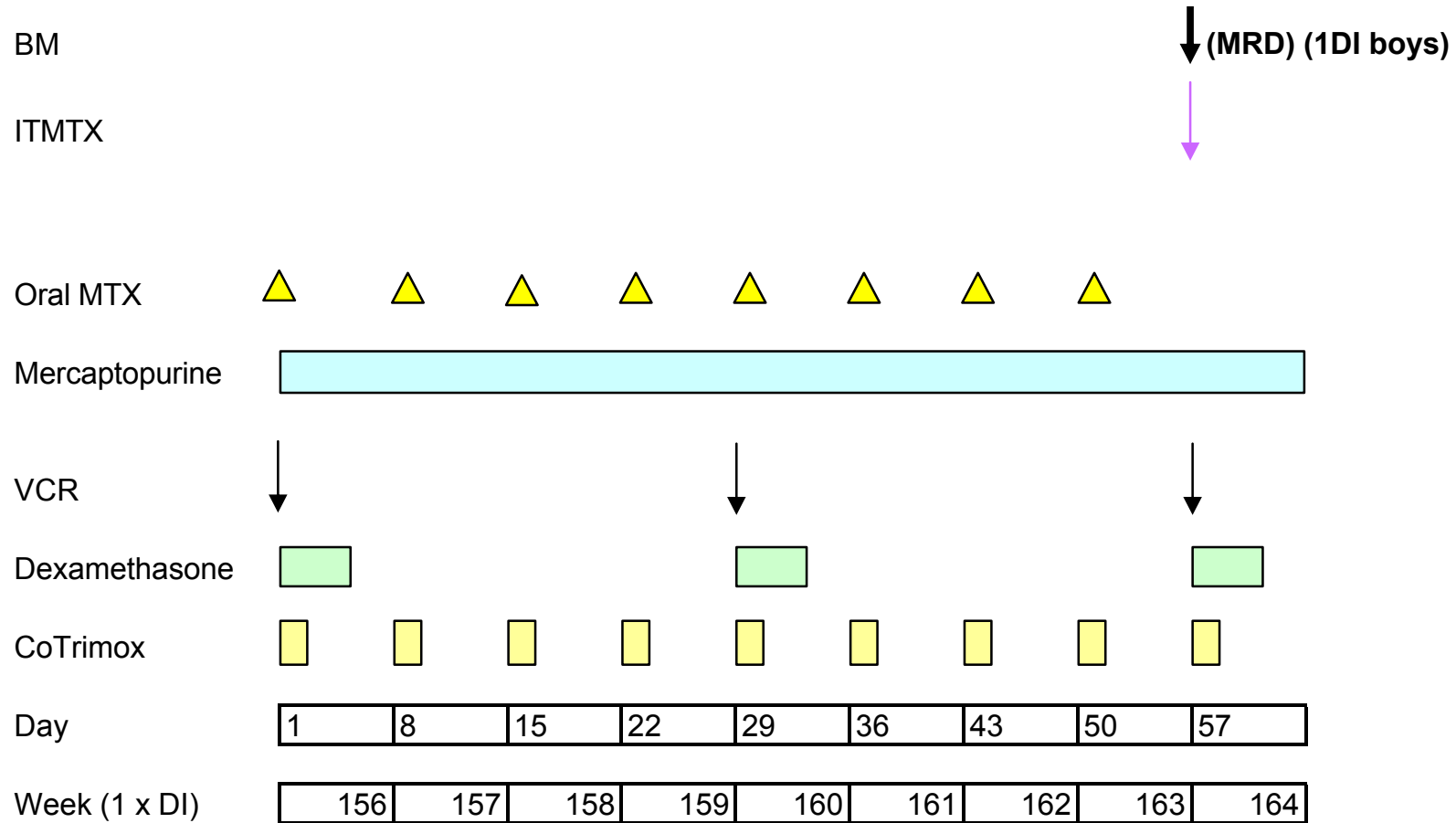

Regimen A Maintenance cycle 12
Flowsheet 7I